

Coating Thickness Gauges



QC5 Models F / N / C / DLF / DLN / DLC

QC5 User Manual

Coating Thickness Gauges

P/N: QC5 501 – ENG – Rev. 01 – February 2014

Index

Chapter 1	First steps	
1.1	Know the QC5	1
	1.1.1 Front panel	1
	1.1.2 Connectors	2
1.2	Install and replace batteries	3
1.3	Connecting the probe	5
1.4	The “Q” key	6
1.5	Display illumination and contrast	6
	1.5.1 Display backlight illumination	6
	1.5.2 Display contrast	7
1.6	Locking and unlocking the keypad	7
Chapter 2	Measuring with the QC5	
2.1	Numerical measuring screen	9
2.2	Graphical measuring screen (Histogram)	10
2.3	Numerical measuring screen (Large Numbers)	11
2.4	Keypad functions in all measuring screens	12
2.5	Selecting the type of base	14
2.6	Calibration	15
	2.6.1 Getting started with calibration	15
	2.6.2 Base calibration	16
	2.6.3 Shim 1 calibration	18
	2.6.4 Shim 2 calibration	19
	2.6.5 Calibration memories	20
	2.6.6 Using offset correction	22
Chapter 3	Menu system and editing	
3.1	Instructions on using the menu system	23
	3.1.1 Text editor	24
3.2	Main menu	26
	3.2.1 Change unit	26

	3.2.2	Alarm settings	26
	3.2.3	Select language	27
	3.2.4	Unit information	28
3.3		General configuration options	29
	3.3.1	Set time and date	29
	3.3.2	Set time and date format	30
	3.3.3	Set keypad sensitivity	30
	3.3.4	Set auto-off time	31
	3.3.5	Adjust display contrast	32
	3.3.6	Beep activation	32
	3.3.7	Introduction screen	32
	3.3.8	Owner information	33
	3.3.9	Lock configuration	34
	3.3.10	Model upgrade licenses	35
	3.3.11	Return to factory default settings	36
3.4		Measuring configuration options	37
	3.4.1	Select type of base	37
	3.4.2	Calibration modes	38
	3.4.3	Offset correction	38
	3.4.4	Set number of samples	39
	3.4.5	Set shim values for quick calibration	39
	3.4.6	Select measuring mode	40
	3.4.7	Set histogram range	41
	3.4.8	Layer counter configuration	41
	3.4.9	Select measure mode (Abs / Diff)	43

Chapter 4 Using the Datalogger

	4.1	Understanding how data is organized	44
	4.2	Memory menu	45
	4.3	Creating a file	45

4.4	Actions over single files	46
4.4.1	View data in a single file	47
4.4.2	The "Q" key in a grid	48
4.4.3	The "Q" key in a histogram	49
4.4.4	Send data from a single file	49
4.4.5	Rename a file	50
4.4.6	View file size	50
4.5	Actions over all files	50
4.5.1	Send all files	50
4.5.2	Erase all files	50
4.6	Quick memory menu (Mem key)	51
4.7	Connect to PC with DataCenter	52
4.8	Datalogger configuration	53
4.8.1	Configure communication	54
4.8.2	Capture modes	55
4.8.3	Set number of samples	56
4.8.4	Select fixed batch	56
4.9	Advanced configuration	56
4.9.1	Store every (N) number of samples	56
4.9.2	Record unit settings	56
4.9.3	Record date and time	57

Appendix

Tips on how to measure correctly	58
Technical specifications	59
Additional information	61
Unit maintenance	61
QC5 accessories	62
Error messages	63
Our website: www.demeq.com	64
Technical support	64

Thank you choosing dmq

And thank you for purchasing a QC5 coating thickness gauge.

Company Statement

At dmq we develop, manufacture and distribute software and quality control instruments offering innovation and solutions that come as a direct result of listening to your needs as a user. We apply some of the latest technology available in the industry to build instruments that are robust, precise, and easy to operate.

We are convinced that our products would not be complete without permanent technical and after sales support. So in addition to a great product we offer:

- Quick answers to your inquiries.
- Unlimited access to technical information as well as application notes.
- Special offers for registered customers.
- Firmware and software upgrades at no charge.
- Attention to your inquiries and suggestions.

We hope that the QC5 will meet and exceed your application needs.

General information

Models included in this manual

The information included in this manual applies to all QC5 series coating thickness gauges including models F, DLF, N, DLN, C and DLC.

Registered trademarks

dmq is a registered trademark of Demeq S.R.L and its affiliate companies.

Important notice

The information contained in this manual is intended to educate users on the operation of the QC5 coating thickness gauges. Failure to read and understand this manual can lead to measurement errors. Decisions based on measurements and or results that are erroneous can lead to property damage, personal injury or even death. Demeq S.R.L assumes no responsibility as a result of the improper use of our instruments.

User training

Correct use of a coating thickness gauge requires:

- Knowing your test requirements.
- Having a trained operator.

This manual provides all of the information needed to configure and operate QC5 coating thickness gauges. However there are additional factors that can affect tests done with this instrument. Specific information on those factors is outside the scope of this manual. When in doubt you should always seek expert advice or refer to specific textbooks on coating thickness testing. Additional information can also be found on the internet and through local government agencies as well as in technical institutes.

Measuring Principle

When a low frequency magnetic field is applied on a ferrous substrate, the signal induced by the coil inside the probe is proportional to the distance between the probe and the base.

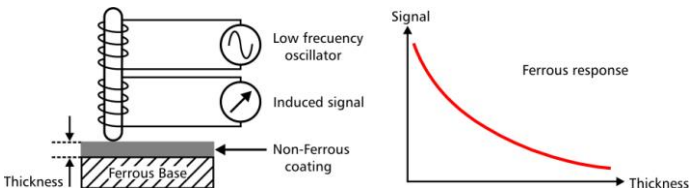

Figure 1: Ferrous base measuring principle

Induced currents are produced on the metal surface when a high frequency field is applied. Induced currents and the signal obtained from the coil are proportional to the distance with the base.

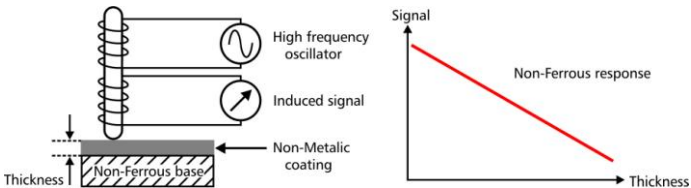

Figure 2: Non-Ferrous base measuring principle

Using the physical principles described above, the QC5 converts small signal variations produced by the probe into precise and repetitive measurements.

Applicable standards

ISO 2178, ASTM D1186 for models QC5 F & QC5 C; ISO 2360, ASTM D1400, ASTM B244 for models QC5 N & QC5 C; and ASTM D7091, ASTM E376 for all QC5 models.

Important: Safety information

All QC5 series coating thickness gauges are for industrial use only. The QC5 operates on two AA size batteries. We strongly recommend that you use only top brand name alkaline batteries.

Disposal of your QC5 and its components must be done in compliance with all applicable regulations.

About the Software

Because of its complexity level, software is never really completely error free. For this reason in software controlled instruments always make sure that the operations required for your application are in correct working order.

Warranty

Demeq S.R.L provides a limited warranty for a period of 5 (five) years on electronic units and for 6 (six) months on probes from the date of purchase.

Every instrument undergoes thorough testing during manufacturing as well as before shipping. In the event warranty service where to become necessary, Demeq S.R.L and or your local distributor or representative will make a reasonable effort to replace your defective unit with another new or used unit, while your instrument undergoes warranty repair.

1 First steps

1.1 Know the QC5

1.1.1 Front panel

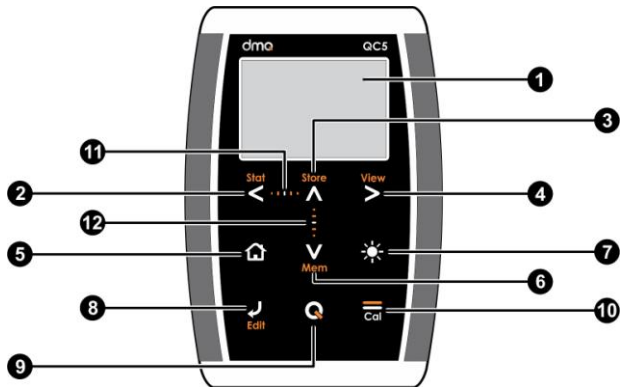

Figure 1.1: Front of the unit

1. Graphic LCD display with LED backlight illumination
2. Move Left key / View partial statistics (Stat)
3. Move Up key / Manually store a value (Store)
4. Move Right key / Switch to graphical measure mode screen (Graph)
5. Menu key / Enter and exit measure screen / Exit and return to menus (Home)

6. Move Down key / Quick access to memory menu screen options (Mem)
7. Change backlight illumination key (On, Off, Auto)
8. Enter key / Edit values on the measure screen (Edit)
9. The **Q** key: Power On and Shutdown (touch and hold for 2 seconds) / Make quick and short touches to activate special features
10. Calibration key
11. Horizontal scrolling center point (lock and unlock keypad on measure screen)
12. Vertical scrolling center point (adjust LCD contrast)

1.1.2 Connectors

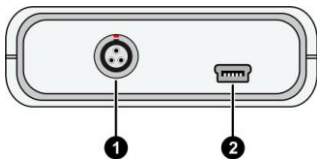

Figure 1.2: Unit connectors

1. Probe connector type Lemo 0B
2. USB mini connector to connect to PC using a USB cable

1.2 Install and replace batteries

The QC5 is powered by 2 (two) AA batteries that are placed in the battery compartment located in the back of the unit. To gain access to the battery compartment slide the cover as shown in figure 1.3-1 and gently push the extraction ribbon upward and slightly towards the right to release the batteries (figure 1.3-2).

When you install new batteries, first insert the positive end of each battery so that it coincides with the positive pole inside the battery compartment as you see in figure 1.4-1.

Always leave the extraction ribbon underneath the batteries.

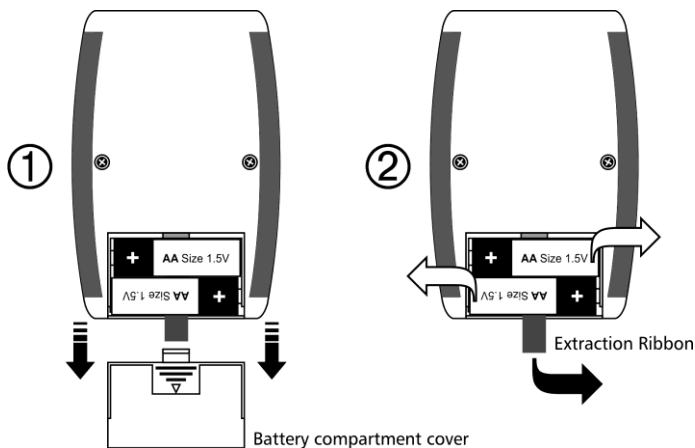

Figure 1.3: Removing batteries

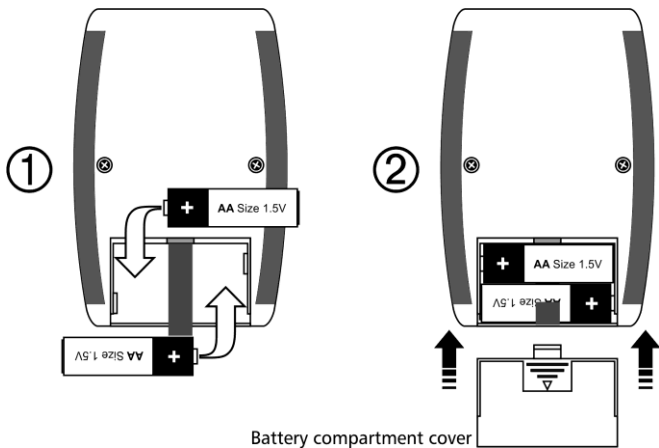
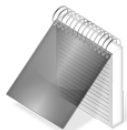

Figure 1.4: Replace / Insert batteries



Notes

Always use new alkaline top brand batteries for extended battery life.

Do not mix new and old batteries. Always replace both batteries.

Rechargeable batteries type NiMH can be used but will result in less time of continuous operation.



Important

Do not remove batteries while the unit is powered as this may affect the Datalogger (See *Appendix: "Additional information, Error Messages"*)

1.3 Connecting the probe

The QC5 uses a type Lemo 0B 4-pin connector located on top of the unit. All dmq probes are provided with Cal-Tag technology allowing you to easily switch or replace probes.

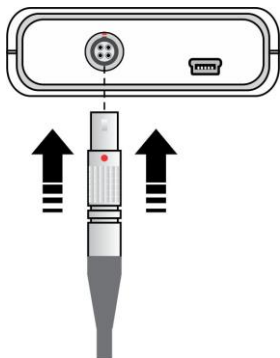

To connect the probe simply align the red dot on the male connector with the red dot on the female connector located on the unit and press gently until connected (see figure 1.5)



To release the probe hold the knurled section on the male connector and gently pull out.

Never remove the connector pushing the cable.

Figure 1.5: Connecting the probe

1.4 The “Q” key

The  has three functions:

1. When the unit is off, touch  for 2 seconds to power on the unit.
2. When the unit is on, touch  for 2 seconds to shutdown the unit.
3. With the unit on, making short touches to the  will activate special functions described in each chapter of this manual.

1.5 Display illumination and contrast

Backlight illumination and contrast options can be changed from any screen in the unit.

1.5.1. Display backlight illumination

Touch  to change the backlight illumination.

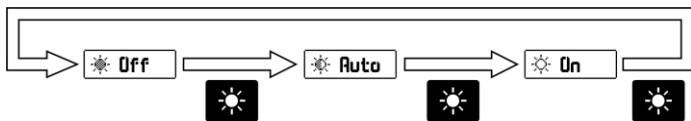
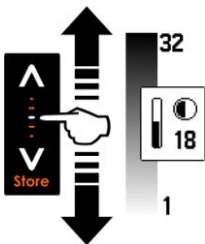

Figure 1.6: Backlight illumination options

1.5.2. Display contrast



The display contrast on all dmq units is digital. Touch the white dot located in the center of the vertical scrolling bar between the **▲** - **▼** keys and a contrast window will open. Move your finger towards the top and or bottom of the dotted line to adjust the contrast on your display.

Figure 1.7: Display contrast adjustment

1.6 Locking and unlocking the keypad

To lock the keypad place your finger on the white dot located in the center of the horizontal scrolling bar between the **◀** - **▲** keys. Move your finger to the right following the dotted line and a window on the unit display will open with the message **Lock** (see figure 1.8). Continue moving your finger in the same direction until you enter blocked mode. The window on the display will close and the blocked keypad indicator will show on the top right of the unit screen.

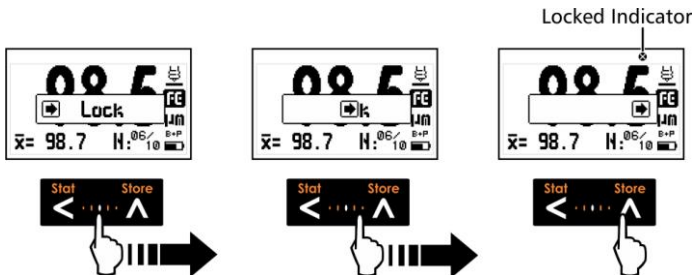

Figure 1.8: Locking the keypad

Sliding the finger to the left will unlock the keypad.

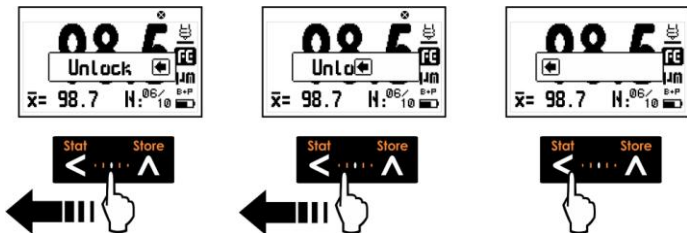



Figure 1.9: Unlocking the keypad



Important

The keypad can only be locked and unlocked in the measuring screens.

2 Measuring with the QC5

The QC5 can display measurements in 3 distinct modes where each mode shows specific information. To switch modes touch the  key.

2.1 Numerical measuring screen

Touch the  key to change the complimentary information displayed on the screen (mode-1 and mode-2).

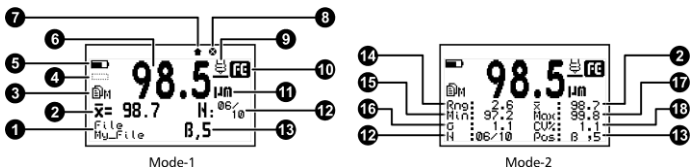



Figure 2.1: Numerical measuring screens

1. Name of the open folder where data is being stored (*Page 45*)
2. Average of the measurements within the group (N values)
3. Datalogger mode indicator: X: Off - M: Manual – U: Single – C: Continuous)
4. Symbol of the measured value as it relates to the nominal value in differential mode (*Page 44*)
5. Battery level indicator
6. Coating thickness value in the selected unit
7. Icon indicating that a value has been stored

8. Blocked keypad icon indicator (Page 7)
9. Probe measuring icon (probe on sample)
10. Type of base icon: FE, NF, A (Page 14)
11. User selected unit
12. Number of (N) values counter / indicator for real time group statistics
13. Position of the last stored value (Column, Row)
14. Range within the group (Max., Min.)
15. Minimum thickness value within the group
16. Average deviation within the group
17. Maximum thickness value within the group
18. Percentage value as compared to the nominal value

2.2 Graphical measuring screen (Histogram)

The QC5 allows you to view graphic representations (histograms) of measured values in real time. And when you touch the  key, the graphic screen will change between mode-1 and mode-2 so that you can view different complimentary information.

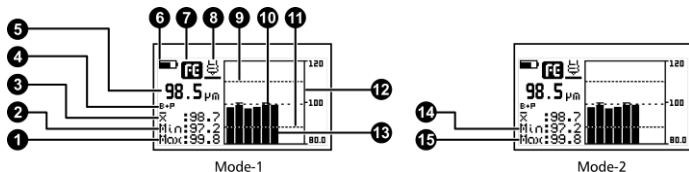

Figure 2.2: Graphical measure screens (mode-1 and mode-2)

1. Maximum thickness value within the group
2. Minimum thickness value within the group
3. Average within the group
4. Active calibration mode (*Page 15*)
5. Actual coating thickness measurement
6. Battery level indicator
7. Type of base icon: FE, NF, A (*Page 14*)
8. Probe measuring icon (probe on sample)
9. High alarm indicator (*Page 26*)
10. Average within group represented graphically
11. Low alarm indicator (*Page 26*)
12. Reference value Y-axis
13. Histogram bars representing individual values
14. Average deviation within the group
15. Range within the group (Max., Min.)

2.3 Numerical measuring screen (Large Numbers)

Measurements are displayed in large numbers with less complimentary information. This mode is used for quick and easy readings.

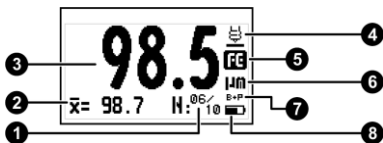



Figure 2.3: Numerical measuring screen (large numbers)

1. Number of (N) values counter / indicator for real time group statistics
2. Average within the group
3. Actual coating thickness measurement
4. Probe measuring icon (probe on sample)
5. Type of base icon: FE, NF, A
6. User selected unit
7. Active calibration mode
8. Battery level indicator

2.4 Keypad functions in all measuring screens

Keys in all measuring screens have the following functions:

Stat : Touch to generate real time statistics based on the number of (N) stored values at the time this function is activated.

Store : Touch to manually store the current measurement in the memory.

View : Touch to switch to measuring screens as follows:

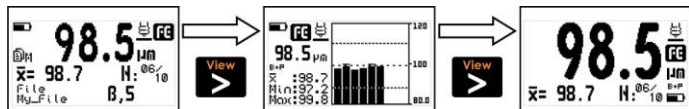





Figure 2.4: Measuring screens

 : Touch to exit the measure screen and enter the main menu.

 : Touch to view quick memory access options.

 : Enter calibration mode (*page 15*).

 : Touch to access the select / edit mode. 2 flashing arrows will appear over editable fields: base and unit.

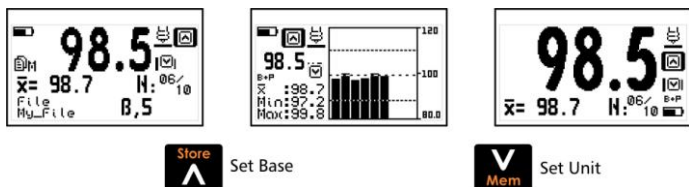





Figure 2.5: Select / edit mode

- To select type of base touch 
- To select unit touch 

In both cases use the  -  keys to edit and touch  to save changes.

 : Short touches allow you to switch screen modes to view different complimentary information. Touch for 2 or more seconds to shutdown the unit.



: Changes the backlight illumination.



: Set display contrast.



: Lock and unlock keypad.

2.5 Selecting the type of base

The QC5 model that you have determines what type of base you can measure: ferrous, non-ferrous, or both. On combined models where you can measure both types of bases, the base selection can be done manually, or automatically where the unit determines the type of base.

Icon	Type of Base	Mode	QC5 model
	Ferrous	Manual	F / C / DLF / DLC
	No-Ferrous	Manual	N / C / DLN / DLC
	Auto	Auto	C / DLC
	Ferrous	Auto	C / DLC
	Non-Ferrous	Auto	C / DLC

2.6 Calibration

The QC5 offers 9 modes of calibration that are explained in detail in this section of the user manual. The following table summarizes all 7 calibration modes:

Abbreviation	Name	Base	PT1	PT2	Samples	Offset
B+P	Base & 1-Pt	●	●	○	1 a 9	No
2PT	2-Points	○	●	●	1 a 9	No
MPT	Multipoint	●	●	●	1 a 9	No
1PT	1-Point	○	●	○	1 a 9	No
BSE	Base only	●	○	○	1 a 9	No
ISO	ISO 19840	●	●	●	5	Yes
SSP	SSPC-PA2	●	●	●	3	Yes
SWE	Swedish SS 184160	○	●	●	5	No
AUS	Australian AS 3894.3	●	●	○	5	No

2.6.1 Getting started with calibration

To begin the calibration process make sure you are in the measuring screen and then touch the  key. If the unit is set to automatic base (C and DLC combined models only) the following screen will appear:

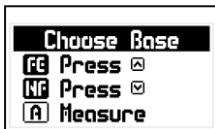



To calibrate over a ferrous base touch  and for non-ferrous touch . If you want the unit to determine the type of base automatically simply go ahead and measure.

Figure 2.6: Base type selection for calibration in combined models

2.6.2 Base calibration

If the calibration mode you selected requires base calibration (measuring an uncoated base), this is the first screen that will appear on the unit:

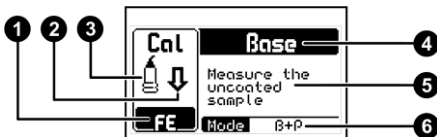
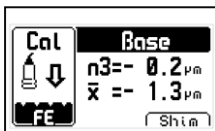

Figure 2.7: Base calibration screen

1. Indicates the type of base as well as its uniformity (*page 17*)
2. "Probe action" requested (lower, raise, or wait)
3. Probe status
4. Type of "sample request" (Base, Shim-1 or Shim-2)
5. Text indicating required action
6. Calibration mode (*page 15*)

When base measurements are taken, the screen will show the number of measurements and the average value for those measurements.



The first line shows the number of measurements followed by the value of the last measurement. The second line shows the average for the number of measurements that you already took.

Figure 2.8: Number of samples in base calibration screen

The graphic representation of the type of base, is also indicative of the base condition. When dirt, corrosion and or other surface irregularities are present on the base material, the graphic will turn less uniform. Sharper “teeth” mean less uniformity of the base material.

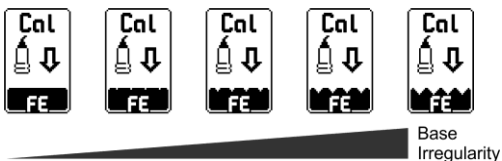



Figure 2.9: Base material condition indicator

On figure 2.8, “Shim” appears on the unit screen. Touch  to end the base calibration and continue the calibration procedure using one or more shims of a known thickness values. The shim option will not appear if the calibration mode is set to “Base Only”.



Important

When the probe is placed on the test piece simple, the probe action indicator (represented by an arrow), gets converted to a sand watch. Here you need to maintain the probe on the test piece until the arrow asking you to raise the probe appears on the unit display.



Lower Probe



Wait



Raise Probe

2.6.3 Shim 1 calibration

After the base calibration procedure is concluded, the unit will ask you to measure using a shim of a known thickness. For the calibration modes that do not require base calibration (1 point, 2 point and Swedish), the calibration process begins here.



Follow the on-screen instructions and measure the shim of a known thickness value over the base.

Figure 2.10: Shim 1 calibration screen

When shim measurements are taken, the unit will display the number of measurements.

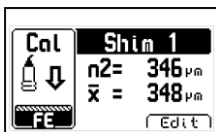

The first line shows the number of measurements followed by the value of the last measurement. The second line shows the average for the number of measurements that you already took.

Figure 2.11: Number of samples in shim 1 calibration screen

Select "Edit" touching the  key to adjust the average value to the nominal value of the shim. This option will not appear on the following calibration modes:

- ISO
- Swedish
- SSPC-PA2
- Australian

For the methods above, the unit will activate the thickness measurement editor only when the required number of samples have been taken.

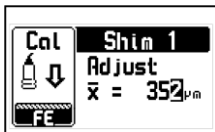



Use the arrow keys to adjust the thickness to the nominal shim value and touch  to save.

Figure 2.12: Shim calibration thickness adjustment screen

With short touches on the  key, preset calibration shim values can be loaded. See **Shim Cal-Q** on page 40. These preset values correspond to the shims that you use most frequently so that thickness values don't have to be edited each time the unit calibrated.

2.6.4 Shim 2 calibration

The calibration modes below require you to measure and adjust results on a second shim of a known thickness value:

- 2-Point
- ISO
- Swedish
- Multipoint
- SSPC-PA2

To calibrate using a second shim, repeat the procedure described under for "Shim 1 calibration" (page 18).

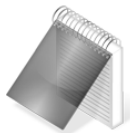

Note

The order in which you use the shims (Shim 1 and Shim 2) based on their thickness is irrelevant.



Tips

Better results with these calibration methods are obtained using shims with lower and higher thickness values than the actual lowest and highest measurements that you will be taking.

The use of shims with thickness values that are not too close to one another is recommended. Ideally the shims should be at least $100\mu\text{m}$ apart from each other.

2.6.5 Calibration Memories

The QC5 can hold 3 calibration memories. To access calibration memories touch the  key on the first calibration screen that you see on the unit.

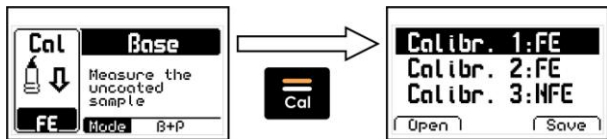





Figure 2.4: Calibration memory menu

Use the   to select one of the three calibration memories and touch the  to Open and load, or touch  to Save the current calibration.

To exit the calibration memory menu touch .



Important

In order to obtain better results with your QC5, calibrate using a the test piece that you are actually going to measure or use a test piece sample that is in the same condition. Wrong use of calibration memories can lead to measurements with greater errors if calibration was done using samples that are not comparable to the actual test piece that you want to measure.



Notes

Calibration memories are stored in either a Ferrous or Non-Ferrous base with the corresponding abbreviation (FE or NF) shown next to the actual value.

When using a stored calibration, the unit should be set to the same type of base as the selected calibration memory.

If the unit is set to automatic base detection, the calibration memory will use the type of base selected at the beginning of the procedure.

2.6.6 Using offset correction

The QC5 allows you to increase or decrease a value (offset) to adjust for errors produced by surface irregularities. Correction values depend on the surface profile as described in the ISO 19840 standard and in the following table:

Surface profile according to ISO 8503-1	Correction in μm
Fine	10 μm
Medium	25 μm
Coarse	40 μm

The calibration modes where offset correction is accepted are the ISO and Australian modes. For additional information on offset correction refer to page 39.

3 Menu system and editing

3.1 Instructions on using the menu system

The instructions explained in this chapter apply to all of the menus in the unit.

To scroll QC5 menu options use the **▲** **▼** cursor keys. When you reach the end of the menu and move to the next menu option it becomes circular as shown herein.

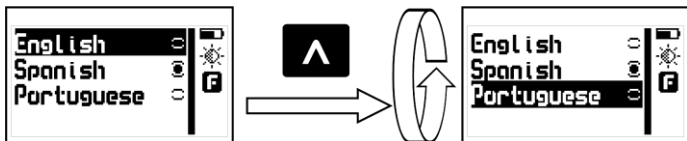

Figure 3.1: Example of how a circular menu works

To select a menu option touch **↵** and to exit and return to the previous menu touch **🏠**.

To go to the measuring screen touch **🏠** from the main menu, or touch **Cal** from any other menu in the unit.

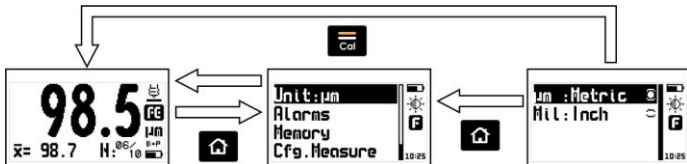

Figure 3.2: Going to the measure screen

3.1.1 Text Editor

The text editor is used to input, modify and delete; letters, numbers and symbols.



Figure 3.3: Alphanumeric editor screens

1. Selected key
2. Cursor
3. Text to be edited
4. Virtual keyboard

Use the cursor keys on the unit to scroll the virtual keyboard until you find the character that you want to use and touch  to select.

Touch the  key to move to the upper case virtual keyboard and to the numbers and symbols keyboard as seen on figure 3.3.

There are 4 keys that are common to all virtual keyboard screens:

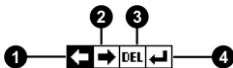

Figure 3.4: Common virtual keyboard keys

1. Move cursor to the left
2. Move cursor to the right
3. Delete character on which cursor is on
4. Enter and exit

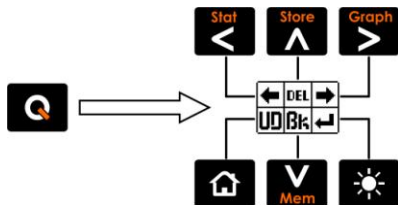



Figure 3.5: Quick access keys for the virtual keyboard editor

Touch the  key to open the direct access keyboard to the most commonly used virtual keyboard keys. Each virtual key corresponds to a key on the front panel of the unit as follows:



: Move the cursor to the left



: Erase the character on which the cursor sits



: Move the cursor to the right



: Undo



: Erase the character to the left of the cursor



: Enter and exit

To close the virtual keyboard touch .

3.2 Main menu



The main menu is the first list of options you will see when you exit the measuring screen and it includes the most important unit settings.



Touch  from the measuring screen to access this menu.

Figure 3.6: Main menu

Note: Memory, Cfg. General, and Cfg. Measure options are explained later in this manual in chapter 4, and in sections 3.3 and 3.4 of this same chapter.

3.2.1 Change unit

Unit:

Touch  on **Unit** in the main menu to open the list of available units.



Use the  -  keys to scroll the menu.

Touch  to select the unit.



Touch  to save and exit this menu.

Figure 3.7: Unit options menu

3.2.2 Alarm Settings

Alarms

The QC5 has high and low alarm conditions that alert the operator when the measurement is greater than the value set for the high alarm and or when the measurement falls below the value set for the low alarm.

Touch  on **Alarms** to open the alarm menu options.

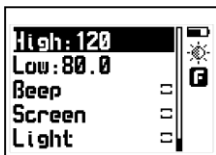

Touch  on **High** or **Low** to open the numbers editor where you can set alarm values using the cursor keys.

Touch  to save the alarm value that you entered and to return to the previous menu.

Figure 3.8: Alarm menu options

Alarm types that you can choose include:

Beep: Audible intermittent alarm type.

Screen: Visible alarm that causes measurements to be displayed in dotted instead of regular numbers.

Light: Visible alarm that activates the display backlight illumination causing it to flash.

3.2.3 Select language

Language

Touch  on language (which is also identified with a flag) to view available language options.



Use the cursor keys to navigate available language options and touch  to select.

Touch  to save and exit this menu.

Figure 3.9: Language menu options



3.2.4 Unit information

Unit Info

Select **Unit Info** to view information including owner data as well as the software version that your unit is running.

Name Phone mail@ Domain.com	deneer QC5-DLC Serial: 10001 Hard: 001-001 28/02/14	Soft: 1.01.002 28/03/10 OS: 1.02.002 28/03/10	VH: 001.019 KDev: 00020 CDev: 00002 (C) 00014 (U)
--------------------------------------	--	--	--

Figure 3.10: Unit information screens

To switch between unit information screens touch the   keys.

To return to the main menu touch .

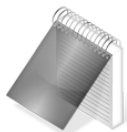

Note

The information required to obtain model upgrade licenses is included in this option.

3.3. General configuration options

Cfg. General

Touch  on the Cfg. Configure option to open the general configuration options menu.

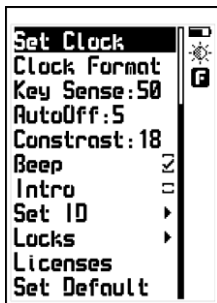

Use the  -  keys to scroll the menu.

Touch  to select any of the menu options.

Touch  to exit and to return to the previous menu.

Figure 3.10: General configuration options menu

3.3.1 Set time and date

Set Clock



Choose Set Clock to open the time editor and use the cursor keys to set the time. Touch  to save and to enter the date editor screen. After you change the date touch  to save and exit.



Figure 3.11: Time and date edit screens

3.3.2 Set time and date format

Clock Format

Choose Clock Format to open the menu that allows you to set the time format (12Hs or 24Hs) and the date format (D/M/Y – M/D/Y).









Touch  on the option you wish to select and touch  to save and exit.

Figure 3.12: Date and time format menu options

3.3.3 Set keypad sensitivity

Key Sense:

This option allows you to set the keypad sensitivity. The number that you set here has a direct relationship to the sensitivity of your keypad meaning that the higher the number, the more sensitive the keypad becomes.

Touch  on Key Sens. and use the   keys to change the keypad sensitivity. Touch  to save and the keypad will already be working with the new sensitivity level.

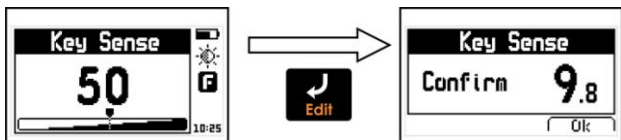



Figure 3.13: Key sensitivity setting and confirmation screens

To confirm the change in sensitivity touch . If you touch any other key or the on-screen counter reaches 0.0, the sensitivity will return to

its previous setting.

The factory default setting is 50. Under special conditions we suggest that the sensitivity level be changed.



Tips

If the unit will be operated using security gloves we recommend that the sensitivity level be raised.

To make the keypad “harder” simply lower the sensitivity level.

In applications where the front of the unit may be exposed to water and or vapors the sensitivity should be lowered.



3.3.4 Set auto-off time

AutoOff:

The unit will shutdown automatically if no key is touched or no measurement is made after a time set by you.

Touch  on **AutoOff** to set the time before the unit automatically shuts down.



Touch the   keys to set the time and touch  to save and exit.

Touch  to exit without making changes.

Figure 3.14: AutoOff time setting screen

3.3.5 Adjust display contrast

Contrast:





Contrast settings allow you to turn your screen lighter or darker where 1 is the lightest and 32 is the darkest. Touch  on **Contrast** and use the   keys to change the contrast on your screen. Touch  to save or touch  to exit without making changes.



Figure 3.15: Screen contrast settings



Tips

Contrast on LCD screens can change with temperature. Use the contrast option to compensate for changes caused by temperature to maintain optimal viewing conditions.

3.3.6 Beep Activation

Beep

Beep refers to the sounds that the unit makes when keys are touched and when the audible alarm is active.

Touch  to enable or disable the beep option.

3.3.7 Introduction screen



Intro

The introduction screen is the first screen that you see after the unit is turned on and includes owner information such as name, telephone number and e-mail. Touch  to enable or disable this option.

3.3.8 Owner information

Set ID

This option allows you to enter owner information (the info that would appear on the introduction screen).

Touch  on **Set ID**, enter the password (the factory default password is 12345) and touch  to access user info menu options.

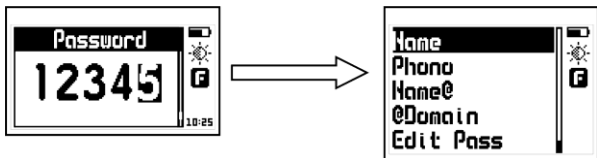

Figure 3.16: Enter password to access the user info menu

The user information that can be changed includes the following:

Name: Set or change the owner name.

Phone: Set or change the telephone number.

Name@: Set or change the e-mail (before the @).

@Domain: Set or change the domain for the e-mail (after the @).

Edit Pass: Allows you to change the password needed to access this menu.

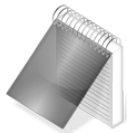

Notes

To set or change text see page 24.

When showing user information, the e-mail address is displayed as "Name@Domain".





Important

The factory default password is 12345. You can change this password after adding your user information.

3.3.9 Lock configurations

Locks

Certain configuration options on your QC5 unit can be locked in order to avoid unwanted changes. Use of the locking options allow a supervisor to optimize unit configuration settings required for a specific test and then pass the unit on to an operator for him or her to conduct the actual measurements knowing that the unit has been properly configured and that the settings cannot be changed.

Touch  on **Locks**, enter your password and then touch  again to view the configuration options that can be locked.

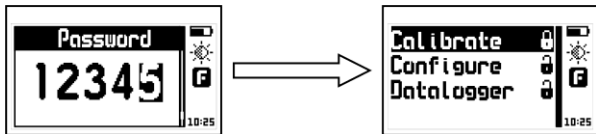

Figure 3.17: Enter password and options lock menu

Each option is followed by a lock indicating whether the feature is locked (closed lock) or unlocked (open lock).

Touch  on each of the following options to lock or unlock:

Calibration: Lock or unlock the calibration option.

Configure: Lock or unlock configuration options such as calibration mode and type of base selection.

Datalogger: Lock or unlock Datalogger configuration options.

3.3.10 Model upgrade licenses

Licenses

QC5 models can be changed with software licenses that you can purchase from Demeq. If you want to purchase an upgrade license we will need to know the following information:

- Unit model
- Unit serial number
- The type of license that you would like to purchase

Touch  on **Licenses** to view all licenses available for your unit (checkmarks indicate active licenses).





To enter the new license number that you purchased touch  or to exit and return to the previous screen touch .

Figure 3.18: Licenses screen



Use the cursor keys to enter the license number and touch  to save.

Figure 3.19: Enter license screen

After you enter the new license number the unit will respond with one of the following messages:



Wrong license password message



Correct license password message

Figure 3.20: Response messages after a license is entered

If the license number that you entered is correct the unit will show an updated license screen where the newly purchased license appears followed by a checkmark.

3.3.11 Return to factory default settings **Set Default**

Choose **Set Default** to return to the original factory default general configuration options.

Touch  and a confirmation screen will appear.





Touch  to confirm and return to the previous menu or touch  to exit without making changes.

Figure 3.21: Set factory default settings confirmation screen

3.4 Measuring configuration options

Cfg. Measure



Select **Cfg. Measure** from the main menu to display measuring configuration options.

Correctly setting these options is critical in obtaining reliable measurements.



Figure 3.22: Measuring configuration options menu

3.4.1 Select type of base

Base:

Touch  on Base to select the type of base you will be measuring on.



Use the   keys to scroll all menu options and touch  to select.



To exit without making changes touch .

Figure 3.23: Select the type of base menu

The type of base, with the corresponding icon (see page 9), will always be displayed in the measuring screen as well as in all other screens (in a group of icons located to the right of the screen, third icon from top to bottom).

3.4.2 Calibration modes

Calibr. Mode

Touch  on **Calibr. Mode** to view all calibration modes. For more details on each calibration mode, refer to section 2.6 on page 15 of this manual.

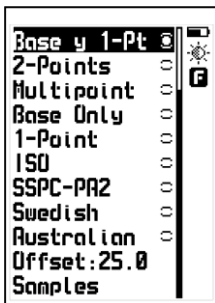

Use the   keys to scroll all menu options and touch  to select.



To exit without making changes touch .

Figure 3.24: Calibration mode menu

3.4.3 Offset correction

Offset

Touch  to adjust the offset value by adding or deducting from the thickness measurement. This is done to adjust for surface irregularities and is accepted in the ISO and Australian calibration methods.



Use the cursor keys to change the offset value and touch  to confirm and exit.



Touch  to exit without changes.

Figure 3.25: Offset adjustment



With short touches on the  key change the sign of the value. For more information regarding offset adjustment see page 22.

3.4.4 Set number of samples

Samples

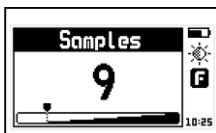
Touch  on **Samples** to set the maximum number of samples that the unit will accept when calibrating. In ISO, SSPC-PA2, Swedish and Australian calibration modes the number of samples is preset but can also be edited. In other calibration modes, the number of samples cannot be modified.



Touch the   keys to change the number of samples and touch  to confirm and exit.



Touch  to exit without changes.

Figure 3.26: Set number of samples

3.4.5 Set shim values for quick calibration

Cal-Q Shims

Touch  on **Cal-Q Shims** to enter the menu where your most frequently shim values used for calibration can be edited and entered. These same values can later on be sequentially loaded when shim thicknesses have to be adjusted during calibration resulting in a quicker calibration procedure. To load **Cal-Q** values, make short touches on the  key when editing shim values during the calibration procedure.

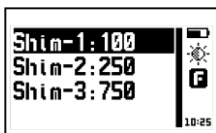

Use the   keys to scroll all menu options and touch  to edit.



To exit without making changes touch .



Figure 3.27: Set shim values for quick calibration

3.4.6 Select measuring mode

Measure Mode

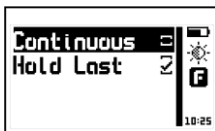
Touch  on Measure Mode to open the measure modes options menu.



Use the   keys to scroll all menu options and touch  to select and enable.

To disable touch  again.

To exit without making changes touch .

Figure 3.28: Measure mode options menu

When **Continuous** is enabled, the unit will measure at a rate of up to 99 readings per minute and will continue to measure for as long as the probe is not lifted. If Continuous is disabled, the unit takes individual readings each time the probe is coupled. To obtain measurements in this mode, the probe must be coupled and lifted each time.

When you enable the **Hold last** option the last measured value will be displayed on the unit screen even when the probe is lifted. When hold last is disabled and the probe is lifted the unit display will read "---".

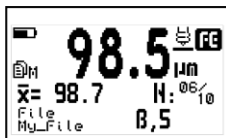

Hold Last mode on

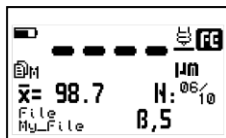

Hold Last mode off

Figure 3.29: Screens with "hold last" enabled and disabled

3.4.7 Set histogram range

Histo Range

Here you can set high and low values that will be represented on the vertical axis of the histogram.

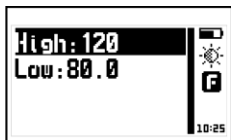

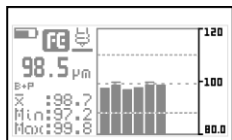

Set histogram range menu



Range view in graphic mode

Figure 3.30: Set histogram range

Touch  on **Histo Range** to open the histogram menu.

Touch  on **High** or **Low** to open the numbers editor where you can set values using the cursor keys. Touch  to save and return to the previous menu.

3.4.8 Layer counter configuration

Count

The QC5 allows you to measure coatings where several layers have been applied. This is done knowing the thickness of at least one layer in order to then count the number of layers.

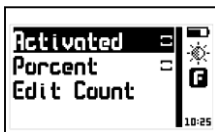

Use the   keys to scroll all menu options and touch  to select and enable.

Touch  to exit without changes.

Figure 3.31: Counter configuration menu



Touch  on **Activate** to enable the number of layers in an absolute value, or select **Percentage** to display as a percentage of the total coating thickness.





Figure 3.32: Activated count layer mode

The count layer mode is not represented in graphic modes.

To set the known layer thickness, go to the **Edit Counter** option in the counter configuration menu and touch .



Use the   keys to change the layer thickness and touch  to save and exit.

Touch  to exit without changes.

Figure 3.33: Set layer thickness value

3.4.9 Select measure mode (Abs / Dif)

Measure :

Touch  on Measure to open the measure modes options menu.

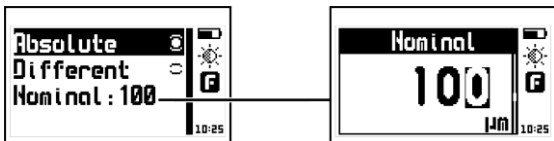





Figure 3.34: Measure mode options menu and set nominal value

The modes in which measurements are represented are:

Absolute: The unit displays the real measured value.

Differential: The value displayed is a result of the value obtained from calculating:

$$\text{Differential} = \text{Real value} - \text{Nominal value}$$

The nominal value is a reference value for the test piece. Touch  on **Nominal** to set this value and touch  to save. To exit without making any changes touch .

4 Using the Datalogger

4.1 Understanding how data is organized

In order to optimize the use of the Datalogger in all QC5 “DL” models, it is important that you understand how data is organized. In the QC5 data is stored in 8 individual files with alphanumeric names. Each file contains a grid with columns and rows. And each grid contains columns (identified with consecutive letters; A, B, ...AA, AB...) that store an “N” number of values or measurements (group). Each value is identified with a column letter and a row number.

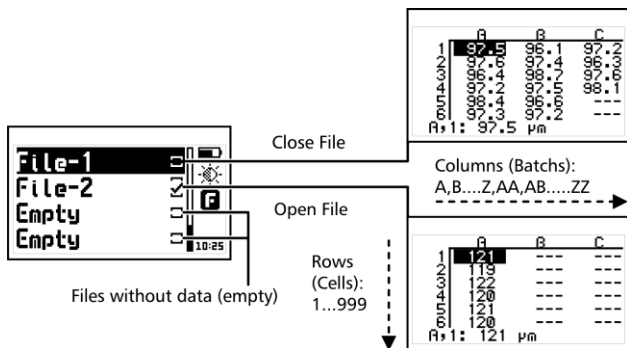

Figure 4.1: How data is organized in the Datalogger

In the above grid structure individual values are stored in a “Column (Batch), Row (Cell)”. So for example F,7 means a value is located in Column F and Row 7.

4.2 Memory menu

Memory



Select **Memory** from the main menu to view all menu options for the Datalogger. This chapter explains how to create, organize, and view files.

Figure 4.2: Memory menu

4.3 Create a file

Touch  on **Files** and use the cursor keys to navigate the list of files in the unit.

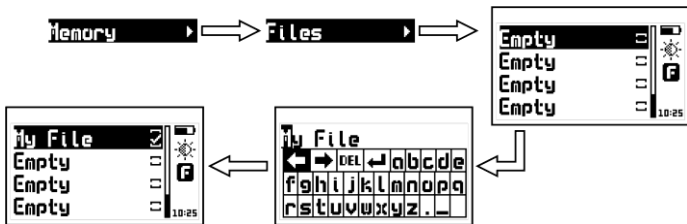



Figure 4.3: Creating a file

Select a file that appears as **Empty** (available file) and touch  to name the file with up to 10 alphanumeric characters.

After you enter a name a checkmark will appear next to it meaning that a new file has been created and is ready to be used.

Remember that only one file can be open at any given time so whenever a new file is created, if a file was already open, the file that was open will be closed. Once a file has been closed, it cannot be reopened and new values can no longer be stored. In closed files, values can only be viewed.

Whenever you create a new file, and another file is already open, a warning screen will ask if you want to close the last file.





Touch  to confirm that you want to close the open file to create (open) a new one or touch  to cancel and return to the menu.

Figure 4.4: Close file confirmation screen

4.4 Actions over single files

Touch  on any file that is not empty and a menu will open with all of the options of what you can do that file.



Figure 4.5: Individual file menu options

4.4.1 View data in a single file

View Data

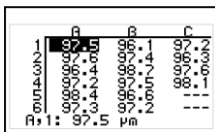





Touch  on **View Data** to view the contents of the file. Touch  to exit the file.

Figure 4.6: File view in grid format

To move inside the grid use the cursor keys.

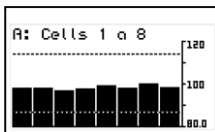

Touch  on a value to open a histogram that includes that same value as well as the values included in the foregoing cells within that column.

Touch  to exit and return to the grid.

Figure 4.7: Columns histogram

High and low hardness alarms appear in the histogram as dotted horizontal lines.

4.4.2 The Q key in a grid

Touch **Q** to open the quick access menu that allows you to go directly to a position inside the grid.

Select the **Row**, **Column**, and **Cell** using the **<** **^** **>** keys.

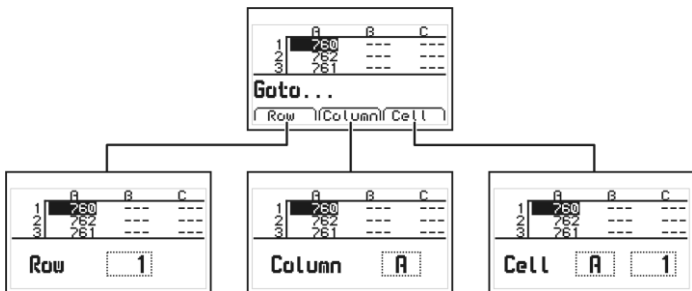



Figure 4.8: Quick access menu options in a grid

Row: Enter a row number using the cursor keys so that when you touch **↩** the grid will position itself directly on that row.

Column: Enter the column letter using the cursor keys so that when you touch **↩** the grid will position itself on that column.

Cell: This is a combination of (column and row) so that you can go to a specific cell after you enter the row number and column letter.

4.4.3 The Q key in a histogram

Touch  in the histogram to open the quick access menu that allows you to obtain statistical information on the group of values being displayed.

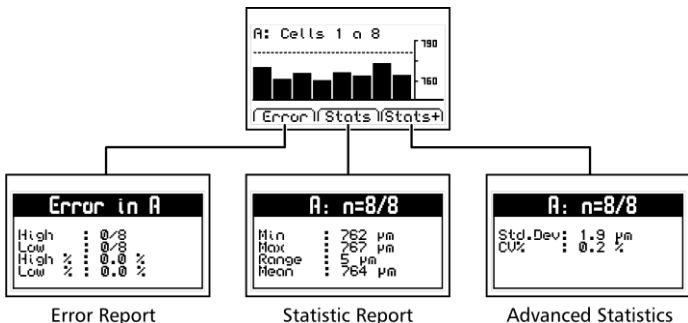

Figure 4.9: Quick access menu options in a histogram

Error: Displays the number of errors and error percentage values in the batch based on the high and low alarm settings.

Stats: View statistical information for the batch including Min., Max., Range and Mean values

Stats+: View the standard deviation and the percentage (coefficient variation) for the batch.

4.4.4 Send data from a single file

Send

Touch  on **Send File** to send (units with Datalogger only) a single file to a PC using Windows HyperTerminal, or to a printer using an RS232 connection. This option does not work in USB mode.

4.4.5 Rename a file

Rename

Touch  on **Rename** to open the text editor that allows you to change the file name.

4.4.6 View file size

Size

Touch  on **Size** to view the number of stored values within a single file (and the size of the file as a percentage of total unit memory). You can also view the date and time in which the file was created.

4.5 Actions over all files

For all





Touch  on **For all** to open the menu for actions that will affect all files stored in the unit memory.

Figure 4.10: Actions over all files menu

4.5.1 Send all files

Send all

Touch  on **Send All** to send (units with Datalogger only) all files stored in the unit memory to a PC using Windows HyperTerminal, or to a printer using an RS232 connection. This option does not work in USB mode.

4.5.2 Erase all files

Erase all

The **Erase All** action permanently deletes all files stored in the unit memory and recovers 100% of the memory capacity.

Before files are deleted, a screen will be displayed asking you to confirm or to cancel this action.

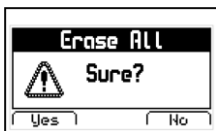

Touch **>** to cancel and return to the previous menu or touch **<** to begin deleting all files.

Figure 4.11: Erase all confirmation screen

When the erase all action has been confirmed the following screens will be displayed:

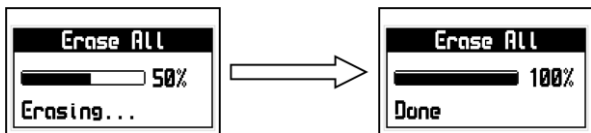

Figure 4.12: Erase all progress screen

4.6 Quick memory menu (Mem key)

Touch **V** on the measuring screen to open the quick memory menu.

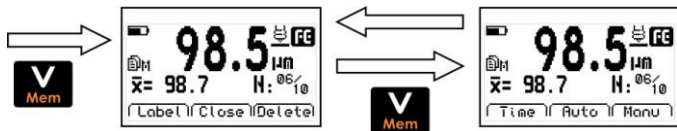

Figure 4.13: Quick memory menu options

In each quick memory menu screen three options are displayed. To access these options use the **<** **^** **>** keys. To change memory screens use the **v** key as seen on figure 4.13.

Options in the first quick access memory screen:

Label: Allows you to tag a value with a number from 0 to 65535 so that it can be easily identified in the grid that you open in DataCenter. Tags are not seen in the grids displayed in the unit.

Close: Close the current file and opens a new one.

Delete: Delete the last stored value.

Options in the second quick access memory screen:

Time: Inserts the time when the value was stored.

Auto: Activates the auto capture mode.

Manu: Activates the manual capture mode.

4.7 Connect to PC with DataCenter

Connect

Touch **↵** on **Connect** to enter the “waiting to connect” mode.

Touch **>** to exit and cancel the connection.

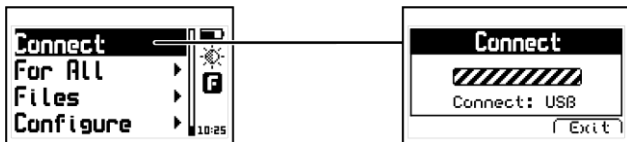

Figure 4.14: Connecting to a PC

With the unit in “waiting to connect” make sure that the USB or the RS232 cable (depending on the type of connecting cable that you are using) is properly connected to both the unit and the PC and click on <Connect> in DataCenter.

When a successful connection is established the files in your unit memory will appear in DataCenter. To view their contents simply double click on each file.

For additional information on dmq DataCenter software refer to the manual included in the CD that you received with your QC5 or download the manual at <http://www.demeq.com/Download.html>

4.8 Datalogger Configuration

Configure

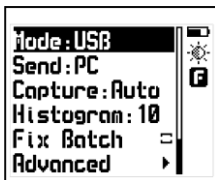

In the memory menu touch  on **Configure** to open the Datalogger configuration options menu.

Figure 4.15: Datalogger configuration options menu

4.8.1 Configure communications

The first two options in the configure Datalogger menu are **Mode** and **Send** which allow you to select how the unit will communicate with a PC or a printer.

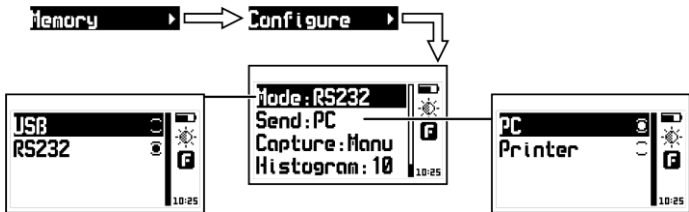



Figure 4.16: Configure communications options

Touch  on Mode to select the type of connection.

USB: Select USB to connect to a PC using a USB cable (included). You must already have DataCenter installed in your PC.

RS232: Select RS232 to connect to a PC or a printer using an RS232 cable (optional).

Touch  on Send to select whether you will send files to a PC or a printer.

PC: When using an RS232 cable, the unit sends data in an optimal format for Windows HyperTerminal (38400-8-N-1).

Print: Using an RS232 cable and printer, the unit sends data in an optimal format for mini-printers of 40 columns (9600/8-N-1).

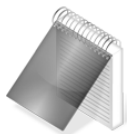

Notes

The print option can only be used in RS232. Files cannot be directly sent to a USB printer.

When you use DataCenter to connect your selection of PC or print will not affect communication.

4.8.2 Capture modes

Capture:

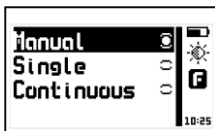



Touch  on **Capture** to select the mode in which values will be stored in the Datalogger.

Figure 4.17: Memory capture modes menu

The QC5 has the following capture modes:

Manual: touch the  key to store values.

Single: each time the probe is coupled a thickness measurement is stored (no other value is stored until the probe is coupled again). In this mode values can also be stored with the  key.

Continuous: when the probe is coupled thickness measurements are continuously stored at a rate of:

2 measurements per second (approx.) / N

Where N refers to a constant value called **Sto. Every** (store every N number of values) that can be set on the **Advanced** Datalogger menu option (page 57).

4.8.3 Set number of values

Histogram

Touch  on **Histogram** to set the number of values that will be included in each batch when the **Fix Batch** option is enabled.

4.8.4 Selecting fixed batch

Fix Batch

When the **Fix Batch** option is enabled the unit automatically closes a batch (and opens a new one) when the number of values set in the histogram is reached. If this option is disabled values are stored in a batch until it is manually closed (Batch option when you touch the “Mem” key from the measuring screen). Touch  to enable or to disable this option.

4.9 Advanced configuration

Advanced





Touch  on **Advanced** to access the advanced configuration options menu for the Datalogger.

Figure 4.18: Advanced configuration options menu

4.9.1 Store every (N) number of samples

Sto. Every



Touch  on **Sto. Every** to set the number of measurements done by the unit before a value (measurement) is actually stored in the Datalogger when **Continuous** capture mode is enabled (page 56).

4.9.2 Record unit settings

History

When you enable history the Datalogger will register unit settings for each measurement that is stored. Information such as type of base and calibration are stored along with the thickness value. This data can only be viewed in a PC using DataCenter.

When history is enabled the unit memory capacity decreases as more data is stored.

Touch  on **History** to enable or disable this option and touch  to exit.

4.9.3 Record date and time

Clock

Touch  on **Clock** to set the time and date options that will be recorded by the Datalogger each time a new batch is opened.

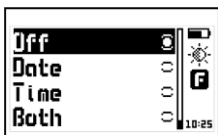





Touch  -  to scroll all menu options and touch  to select and exit. Touch  to exit without making changes.

Figure 4.19: Set registry / clock options for the Datalogger

Clock menu options include:

Off: The Datalogger does not record date and time.

Date: Each time a new batch is opened the Datalogger records the date.

Time: Each time a new batch is opened the Datalogger records the time.

Both: Each time a new batch is opened the Datalogger records the date and time.

Tips on how to measure correctly

In order to obtain reliable measurements calibrate on the same type of base as the parts that you will actually be measuring.

Highest accuracy is obtained when you are closest to the calibration point. This means that whenever possible, you should use shims that are as close as possible to the thickness that you expect to measure.

Use the probe gently over the test piece that you will be measuring. There is no need to press hard.

Do not use lubricants on the probe or any of its components and clean using a dry cloth.

Avoid measuring edges to minimize errors. It is always best to measure away from test piece edges.

When measuring very thin substrates or irregular surfaces, avoid using "1 point" and "Only Base" calibration modes.

Shims can be overlapped (placed over one another) in order to obtain thicker values. But labels should not overlap and should remain visible at all times.

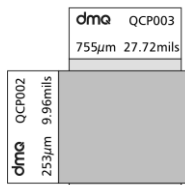

Correct

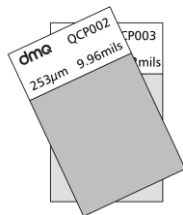

Incorrect

Technical Specifications

Measuring principle	Magnetic induction / Eddy currents
Probes	QCS101 F / N / C (0 to 1500 μm)
Materials (Ferrous)	Iron, Steel, Magnetic Stainless Steel
Materials (Non-Ferr.)	Aluminum, Copper, Bronze, Brass
Units	Microns (μm) / Inches (Mil) / Millimeters (mm)
Resolution (QCS101 Probe)	0 to 99.9 μm : 0.1 μm Above 100 μm : 1 μm 0 to 4.99 Mil : 0.01 Mil Above 5.0 Mil : 0.1 Mil
Measuring range	0 mm to 15 mm (depending on probe)
Accuracy	± 1 to 3% +2 μm * (depending on probe)
Measurement velocity	99 measurements per minute (aprox.)
Calibration modes	Base & 1-Pt, 2-Points, Multipoint, 1-Point, Base only
Applicable standards calibrations	ISO (ISO 19840), SSPC (SSPC-PA2), SWE (SS 184160), AUS (AS 3894.3)
Alarms	Minimum., Maximum - Audible and visual
Statistics	Number of samples, min., max., average, range, standard deviation, variation percentage
Languages	English, Spanish, Portuguese
Datalogger	Capacity of 32000 values organized in up to 8 files with alphanumeric names. Manual, Single, Continuous capture modes. Record Date and Time. View data including statistics in grid or graphic formats.
Connection to PC	USB native or RS232 (optional)
Display	Graphic LCD 128 x 64 pixels with LED backlight illumination and contrast adjustment.

Keypad	Touch-sense with no mechanical parts and sensitivity adjustment.
Battery life	100 hours with 2 each type AA batteries
Operating temperature	- 10°C to + 50°C
Enclosure	High impact ABS with rubber sides. Size is 78 x 117 x 24 mm.
Weight	200 g with batteries

Probes QCS101 F/NF/C specifications

Measuring principle	Magnetic induction / Eddy current
Measuring range	0 to 1500 μm , 0 to 60 Mil
Resolution	0 to 99.9 μm : 0.1 μm Above 100 μm : 1 μm 0 to 4.99 Mil : 0.01 Mil Above 5.0 Mil : 0.1 Mil
Materials (Ferrous)	Iron, Steel, Magnetic Stainless Steel
Materials (Non-Ferrous)	Aluminum, Copper, Bronze, Brass
Min. base thickness	0.1mm (Non-Ferrous), 0.3mm (Ferrous) **
Min. convex radius	2 mm (Ferrous), 5 mm (Non-Ferrous) **
Min. concave radius	25 mm (Ferrous, Non-Ferrous) **
Min. sample	\varnothing 5 mm **
Probe dimensions	\varnothing 12 x 92 mm
Probe weight	50 g (aprox.)

* Except in "1-Point" and "Only Base" calibration modes where errors could be greater.

** To obtain better results calibrate using shim values that are as close as possible to the actual coating thickness.

Additional information

Unit maintenance

The QC5 was developed and manufactured for years of trouble free operation and even though the unit does not require special care the following precautions should be considered:

- Avoid contact with corrosive and abrasive substances.
- Do not clean the unit with solvents.
- Do not leave the unit display exposed to direct solar light for prolonged periods of time as this could damage the display.
- Remove the batteries if the unit will be stored for an extended period of time.
- Remove the probe using the connector and not the cable.
- Do not twist or strangle the probe cable.
- Do not expose the unit to temperatures below -10°C / 14°F or above 50°C / 122°F .

QC5 Accessories

dmq part number	Description
QCM 300	High impact carrying case
QCM 001	Silicone protective boot
QCS 101F	Standard ferrous probe (0 to 1500 μm)
QCS 101N	Standard non-ferrous probe (0 to 1500 μm)
QCS 101C	Standard combined probe (0 to 1500 μm)
QCS 102F	Low range ferrous probe (0 to 500 μm)
QCS 102N	Low range non-ferrous probe (0 to 500 μm)
QCS 103F	Extended range ferrous probe (0 to 5000 μm)
QCS 103N	Extended range non-ferrous probe (0 to 5000 μm)
QCR 001	Low value shim (<100 μm)
QCR 002	Mid-range value shim (between 100 and 500 μm)
QCR 003	High value shim (>500 μm)
QCR 101	Ferrous calibration base
QCR 102	Non-ferrous calibration base
QCL 501	DL (Datalogger) upgrade license
QCL 502	C (Combined) upgrade license
QAC 002	Optional RS232 cable to connect to PC
QAC 003	Optional RS232 cable to connect thermal printer

For additional information and accessories for your QC5 visit www.demeq.com/Accessories-QC.html

Error messages

Error messages may eventually open on your unit screen and are informational only. If one of these messages opens on your display follow the instructions described below and if the problem persists please send us a detailed report at www.demeq.com/form_Support.html



Figure A.2: System error message

Error 1	Internal Error
Cause	Internal Error
Solutions	Shutdown the unit, wait a few seconds, and power back on. Contact Demeq.

Error 2	Attempt to store a value over an existing value.
Cause	Improper unit shutdown (Example: Removing batteries) and powering the unit back on to store values in the Datalogger.
Solution	Download Datalogger values to PC or printer and erase memory.

If a message with a different number were to appear please contact Demeq.

Our website: www.demeq.com

Our website is a powerful customer support tool where you will find the latest information as it relates to your QC5 including:

- Application notes
- Manuals and brochures
- Software updates
- Model upgrade license information
- New accessories

Software updates

To download software updates to your QC5 you must have dmq DataCenter installed on your PC. To download the latest updates for your unit refer to www.demeq.com/Download.html

Technical support

Our service department is committed to providing prompt and courteous service. Should you encounter any trouble with your QC5 please send us a detailed description of your problem to www.demeq.com/form_Support.html

