

A (2 : 1)

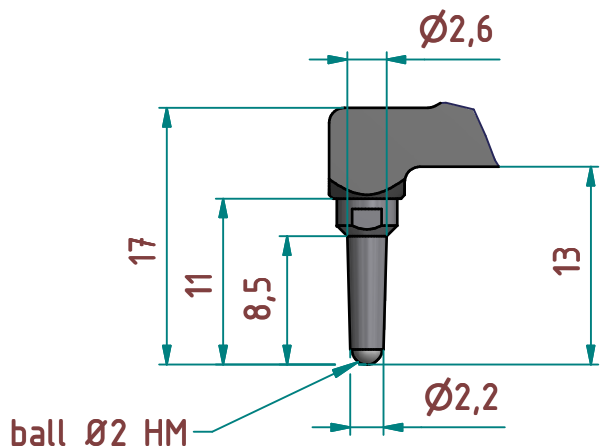

subject to technical alterations

type: M200
range: 100 - 150 mm
range of indication: 99,5 - 150,5 mm
digital step:
scale interval: 0,050 mm
measuring force: 0,9 - 1,9 N
weight: 385 g

acceptable deviations
VDI/VDE/DGQ 2618 Bl. 12.1/13.1)
max. permissible
errors "G": 0,050 mm
repeatability "r": 0,025 mm
reference temperature: 20° C
operation temperature: 10° C - 30° C
storage temperature: -10° C - 50° C

scale: 1 : 2
drawing-nr.: DAB-H4100_KR_en
date of issue: 12.04.2013
name: Lange
revision status:
revision date:

measuring capacity

		measuring range M_{eb} [mm]													
		100	102	104	106	108	110	115	120	125	130	135	140	145	150
groove depth A [mm]	0	0 / 158	0 / 164	0 / 166	0 / 168	0 / 170	0 / 172	0 / 177	0 / 192	0 / 192	0 / 192	0 / 192	0 / 192	0 / 192	0 / 192
	1		2,5 / 163	2,5 / 165	2,5 / 167	2,5 / 169	2,5 / 171	2,5 / 176	2,5 / 183	2,5 / 192	2,5 / 192	2,5 / 192	2,5 / 192	2,5 / 192	2,5 / 192
	2			2,6 / 164	2,6 / 166	2,6 / 168	2,6 / 170	2,6 / 175	2,6 / 180	2,6 / 192	2,6 / 192	2,6 / 192	2,7 / 192	2,7 / 192	2,7 / 192
	3				2,7 / 164	2,6 / 166	2,6 / 168	2,6 / 173	2,7 / 178	2,7 / 192	2,8 / 192	2,8 / 192	2,8 / 192	2,9 / 192	2,9 / 192
	4					2,7 / 165	2,7 / 167	2,7 / 172	2,8 / 177	2,8 / 192	2,9 / 192	2,9 / 192	3,0 / 192	3,0 / 192	3,0 / 192
	5						2,7 / 166	2,8 / 171	2,9 / 176	2,9 / 183	3,0 / 192	3,1 / 192	3,2 / 192	3,2 / 192	3,3 / 192
	B / L														

B = minimum groove width [mm]
L = maximum usable arm length [mm]

Example: $M_{eb} = 106$ B = 2,6
A = 2 L = 166

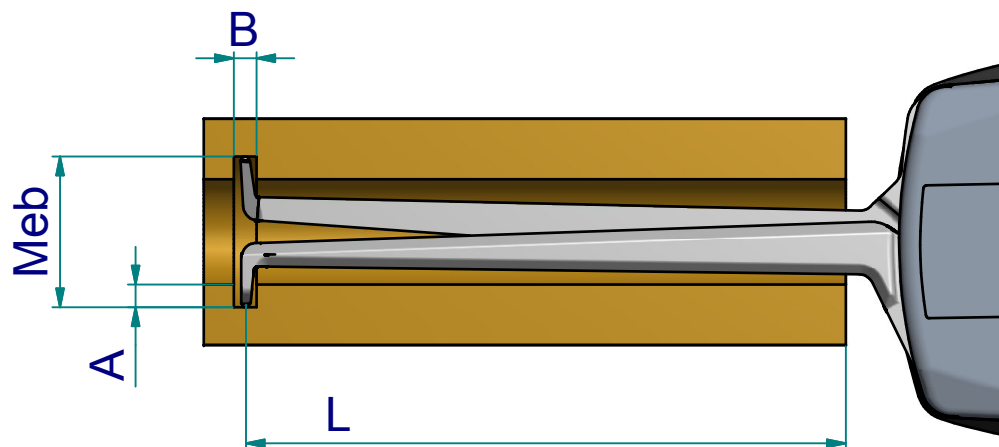

subject to technical alterations

drawing-nr.: DAB-H4100_KR_en
date of issue: 01.07.2013
name: Lange

revision status:
revision date: