

EVF008

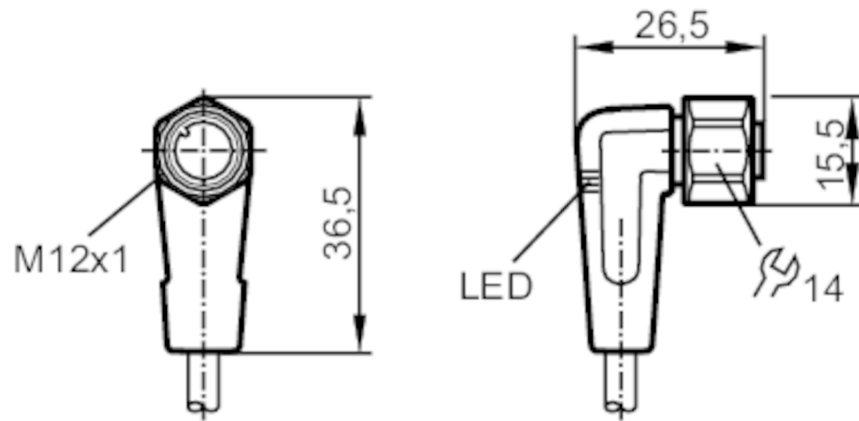

Connecting cable with socket

ADOAH043VAS0010P04



Application

Application	hygienic and wet areas in the food industry
Free from silicone	yes

Electrical data

Operating voltage [V]	10...36 DC
Protection class	II
Max. current load total [A]	4

Outputs

Electrical design	PNP
-------------------	-----

Operating conditions

Ambient temperature [°C]	-25...100
Note on ambient temperature	cULus: ...65 °C
Ambient temperature (moving) [°C]	0...100
Note on ambient temperature (moving)	cULus: ...65 °C
Protection	IP 65; IP 67; IP 68; IP 69K

EVF008



Connecting cable with socket

ADOAH043VAS0010P04

Mechanical data		
Weight [g]	316.5	
Dimensions [mm]	26.5 x 15.5 x 36.5	
Materials	PP Halogen-free; Sealing: EPDM	
Material nut	stainless steel (1.4404 / 316L)	
Drag chain suitability	bending radius for flexible use	min. 10 x cable diameter
	travel speed	max. 3.3 m/s for a horizontal travel length of 5 m and max. acceleration of 5 m/s ²
	bending cycles	> 1 Mio.
	torsional strain	± 180 °/m
Drag chain suitability	yes	

Displays / operating elements		
Display	switching status	2 x LED, yellow
	operation	1 x LED, green

Remarks	
Pack quantity	1 pcs.

Electrical connection	
Cable: 10 m, MPPE, grey, Ø 4.9 mm; 4 x 0.34 mm ² (42 x Ø 0.1 mm)	

Electrical connection - socket
Connector: 1 x M12, angled; Moulded body: PP, Halogen-free; Locking: stainless steel (1.4404 / 316L); Contacts: gold-plated;
Tightening torque: 0.6...1.5 Nm

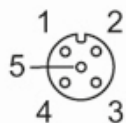

EVF008



Connecting cable with socket

ADOAH043VAS0010P04

Connection



Core colours :

BK = black
BN = brown
BU = blue
WH = white